



FILTER TECHNOLOGY

SAMPLE PREPARATION CATALOG



CHROMATOGRAPHIC 
SPECIALTIES INC.

1-800-267-8103 • www.chromspec.com • tech@chromspec.com



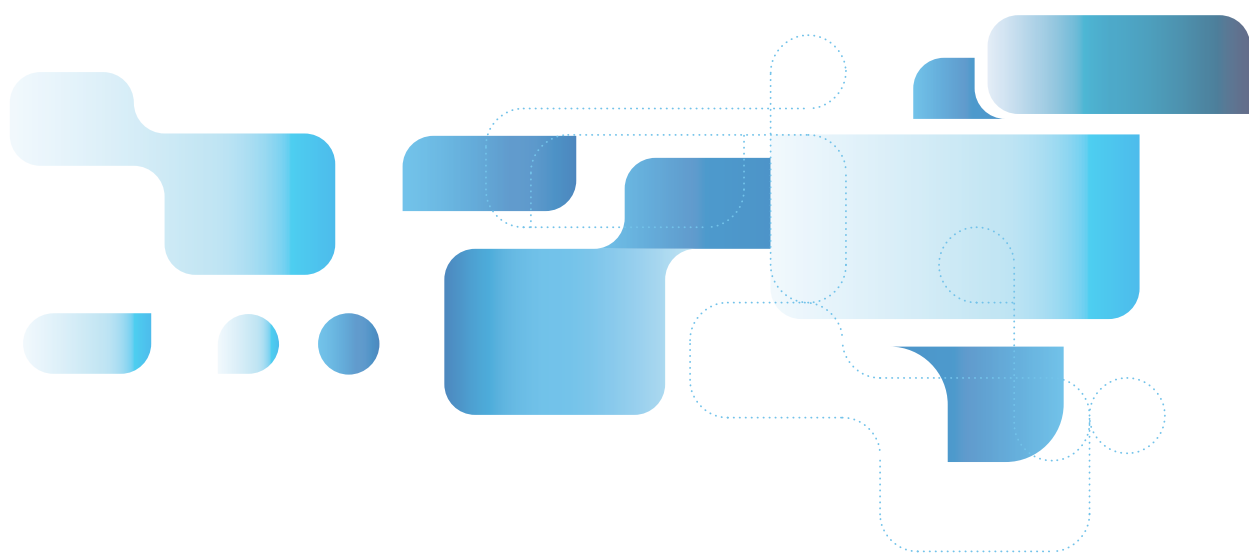

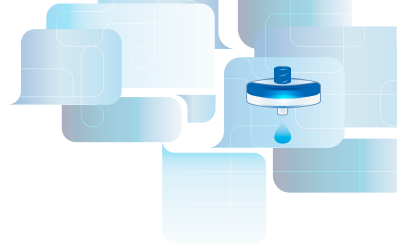

Index

Introduction	_____	2
◆ Sample Preparation Guides		
Syringeless Filters - SEPARA®	_____	7
Syringe Filters		
◆ 13 mm - ABLUO®	_____	8
◆ 17 mm - CAMEO DUALLAYER®	_____	9
◆ 33 mm - ABLUO®	_____	10
◆ 33 mm - CAMEO DUALLAYER™	_____	11
◆ 13 mm Sterile - ABLUO®	_____	12
◆ 33 mm Sterile - ABLUO®	_____	13

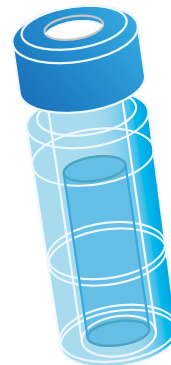
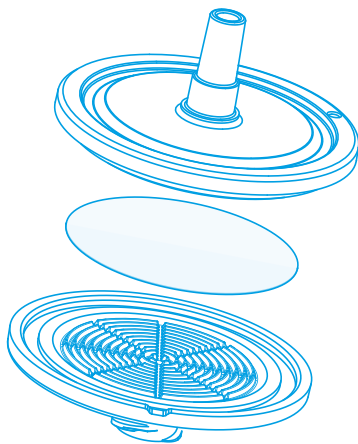

Better performance for certain results

GVS Filter Technologies is constantly looking for new ways to expand our product offering to meet your needs and ease your application challenges. Our product innovations are the result of understanding your applications and valuing the amazing contributions your work can make to the quality of all our lives.

Whether you are pursuing goals in life science, pharmaceutical methods, research and development, quality control, or specialty environmental applications, we commit to not only deliver a product that works, but to look beyond what simply works and deliver a product that truly makes a difference.

GVS Filter Technologies is one of the few companies to offer a variety of products made from the same materials of construction, allowing for single- or multiple-sample processing of your techniques. We bring together membranes with superior performance, outstanding housing materials, and devices designed to maximize processing accuracy and speed.

Filter Media Selection has never been easy!

1. Consider Chemical Compatibility

Chemical compatibility is defined as the ability of a filter material to resist select chemicals so that the pore structure is not adversely affected by chemical exposure, and the filter material does not shed particles or fibers to add extractables. The chemical compatibility information on page 5 will help you make the right choice. Temperature, time, concentration, applied pressure, and length of exposure also affect compatibility.

Extractable Materials

The membrane manufacturer best prevents contaminants that elute from the filter media. GVS Filter Technologies specifically selects the highest grade of materials and performs rigorous extraction methods on our membrane products to reduce the occurrence of undesired artifacts. Choosing membranes that are compatible with your fluids and experimental conditions will reduce or eliminate extractables.

Binding

Membranes may chemically interact with the sample through electrostatic, ionic, covalent, hydrogen bonding, or other interactions. Binding can be a desirable or undesirable characteristic depending on the requirements of the application.

2. Consider Effective Filtration Area (EFA)

The particulate contained within a fluid affects the life of a filter. As particles are removed from a filter, they block pores and reduce the useable portion of the filter. Fluids with particulate loads will plug a filter more quickly than “clean” fluids. Increasing the EFA can lengthen the life of a filter. The Sample Volume Selection Guide on page 6 outlines general guidelines for the most appropriate filter size for different volumes of liquid.

3. Choose the Right Pore Size

Pore size is best selected by considering the instrumentation used for analysis. UV/V spectrophotometers may only require 1 μm filtration; HPLC analysis may require 0.45 μm filtration; and UHPLC will require 0.2 μm filtration due to the size of the column packing, beads, and internal frits. The filter material's pore size is determined by the diameter of the smallest particle that is to be retained with a defined, high degree of efficiency. For standard liquid chromatography systems using columns with 5 μm or larger packings, the filtration industry standard is 0.45 μm for syringe filters and mobile phase membranes.

For columns with packings smaller than 5 μm , UHPLC, microbore columns, or when concerned about microbial growth, a 0.2 μm filter is recommended. To clarify samples or when processing difficult-to-filter solutions, 1 to 5 μm pore sizes or glass fiber filters are suggested. Prefilters generally precede smaller pore size final filters and allow the user to process larger fluid volumes before the filter plugs.



The GVS Life Sciences Sample Preparation Family



GVS Life Sciences offers a range of disposable syringe filter devices designed to provide fast and efficient filtration of aqueous and organic solutions. They are available in a wide variety of sizes and membranes, with a polypropylene or acrylic housing, for both sterile and non sterile laboratory applications.



Features and Benefits

- ◆ Lower hold-up volume - due to an improved flow channel design and reduced spacing between the supports within the housing, for better handling of small sample volumes or costly samples
- ◆ Increased operating pressure - up to 80 psi due to the over-mold that prevents sample leaking at the seam and keeps the filter unit from bursting in half
- ◆ Strict quality control - syringe filters are integrity tested to ensure a proper fit and weld to eliminate any potential filter by-pass
- ◆ Accurate labeling - each filter is labeled with the specific filter material and pore size for easy identification even if the syringe filter is not in its original packaging
- ◆ Multifunctional connectors - equipped with male luer-lock or male slip and female luer-lock connections
- ◆ Polypropylene or Acrylic housing
- ◆ Modified Acrylic housing to bidirectionally support the membrane allowing sample injection or aspiration
- ◆ Sterile or Non-Sterile options
- ◆ Bulk-packages or individual blisters
- ◆ Customized product and packaging on request
- ◆ Manufactured in the USA - GVS Life Sciences devices are manufactured in our ISO9001 certified plant in Sanford, Maine, USA, using proprietary microporous membranes from our plant in Westborough, Massachusetts, USA.

HPLC Sample Preparation

Products Selection Guide

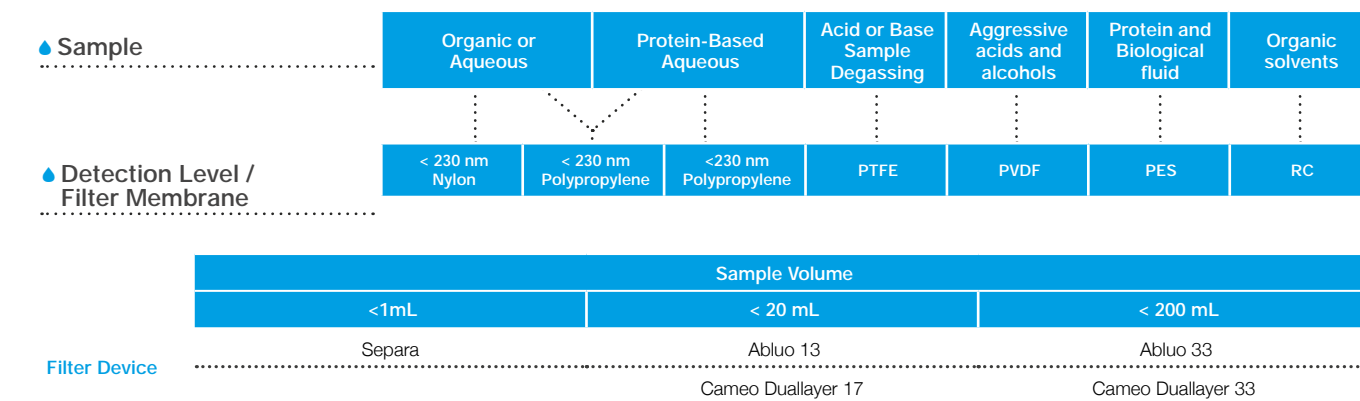

Pore Size

Filters come in a variety of pore sizes. The most common ones used in physical chemistry laboratories are 0.2 µm and 0.45µm. Generally, 0.45µm is sufficient for the majority of procedures. However, where smaller particles may be present in the sample 0.2 µm or 0.1 µm might be more appropriate. If you need to filter a smaller particle size (for example, to remove colloids) other types of filtration may be more appropriate

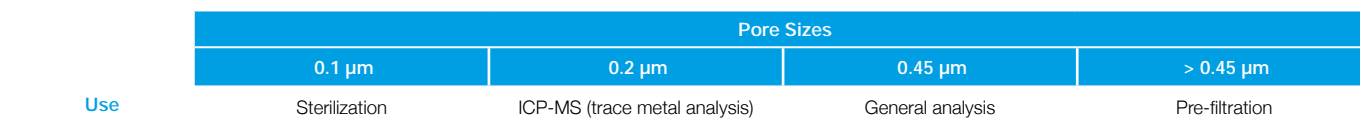

Tissue Culture Media

Sample Preparation Products Selection Guide

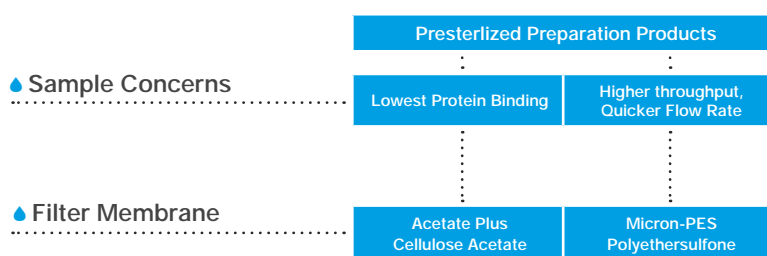

Cell and Particulate Analysis

Filter Membrane Selection Chart



Material	Code	Property	Features	Application
Cellulose Acetate	CA	Excellent flow rates. Very low protein binding, so they are suitable for protein recovery applications. Hydrophilic, so fine for aqueous and alcoholic media although they have limited solvent resistance. pH range ~4-8.	<ul style="list-style-type: none"> Lowest Binding Material Available Highest Throughput Strength and Dimension Stability Uniform Pore Structure Hydrophilic 	<ul style="list-style-type: none"> Tissue Culture Media Sterilization Protein and Enzyme Filtration, Sterilization Biological Fluid Filtration, Sterilization Uniform Pore Structure Hydrophilic
Glass Microfibre	GMF	Chemically inert and available in higher pore sizes than other membranes. Mechanically extremely strong and tolerant to organic solvents. Not idea with strong acids (particularly hydrofluoric acid) or bases. Ideal for high particulates solutions, often used as a pre-filter before a membrane filter. Not a membrane filter and so has a slightly less exact retention efficiency than membranes. Will contribute extractables that interfere with ionic and metals analysis.	<ul style="list-style-type: none"> Biologically Inert Available With or Without Acrylic Binders High Dirt-Holding Capacity 	<ul style="list-style-type: none"> Gravimetric Analysis Prefilter to Extend Final Filter Life Clarification of Particulate Laden Solutions
Nitrocellulose	NC	High mechanical strength, high flow rates, and low extractable levels. A good choice for trace element analysis applications. High protein binding. pH range ~4-8.	<ul style="list-style-type: none"> Consistent Flow Rates High Throughputs Uniform Pore Structure Hydrophilic 	<ul style="list-style-type: none"> Aqueous Filtration Microbiological Analysis Sterility Testing Gravimetric Analysis With Ashing Technique Particulate Analysis
Nylon	NY	Nylon membrane filters are hydrophilic, flexible, tear-resistant, and autoclavable. They are resistant to a range of organic solvents and suitable for use with high pH samples. Nylon binds proteins. Unsuitable for acidic solutions. pH range ~3-14.	<ul style="list-style-type: none"> Naturally Hydrophilic Wide Chemical Compatibility Range Extremely Low Extractables Strength and Dimensional Stability 	<ul style="list-style-type: none"> Sterilization, Clarification of Aqueous and Organic Solvent Solutions HPLC Sample Preparation
Polypropylene	PP	Slightly hydrophobic, can be used with a very wide range of solvents including aggressive hard-to-filter solutions such as strongly acidic samples. High and uniform tolerance to heat and mechanical stress. pH range ~1-14.	<ul style="list-style-type: none"> Chemically and Biologically Inert Wide Chemical Compatibility Range Extremely Low Extractables Low Fiber Release More Defined Pore Size and Greater Retention Efficiency Than Glass Prefilters 	<ul style="list-style-type: none"> Sterilization, Clarification of Organic Solvent Solutions 0.1, 0.22, 0.45 27 HPLC Sample Preparation Prefilter to Extend Final Filter Life Final Filter for Noncritical Filtrations Prefiltering Solvents and Acids
Polyethersulfone	PES	Hydrophilic, stable in low pH, have low levels of extractables, and exhibit low protein binding, making them suitable for many aqueous and organic solvents. PES membranes allow higher liquid flow than PTFE. Temperature resistant. pH range ~3-14 (sometimes quoted as 1-14).	<ul style="list-style-type: none"> Low Protein Binding Low Extractables Autoclavable Wide Chemical Compatibility Range Strength and Dimensional Stability High Flow Rates Excellent Sample Recovery Controlled Pore Structures 	<ul style="list-style-type: none"> Tissue Culture Media Sterilization Protein and Enzyme Filtration, Sterilization Biological Fluid Filtration, Sterilization Purify and Concentrate Proteins, Enzymes, Nucleic Acids and Antibodies Desalt
Polytetrafluoroethylene (Teflon)	PTFE	Is perfect for the filtration of gaseous or organic solvent-based samples and highly corrosive substances. Hydrophobic so provides chemical resistance to aggressive media and excellent temperature stability allowing an extended sampling range. If used with aqueous samples, the membrane usually requires pre-wetting (normally by using a small amount of alcohol). Can also be used to prevent moisture passing through air vents. pH range ~1-14.	<ul style="list-style-type: none"> Naturally Hydrophobic Compatible with Strong Acids and aggressive Solvents Improved Durability and Handling Natural Hydrophobic Compatible with High Temperatures Chemically and Biologically Inert 	<ul style="list-style-type: none"> Filtration of Strong Acids and Aggressive Solvents Venting Applications Filtration of High Temperature Acids and Solvents
Polytetrafluoroethylene Hydrophilic (Teflon)	PTFE	PTFE provides device manufacturers with a consistent, temperature and chemical compatible barrier to microbes and particulate matter. The optimal combination of air flow and water entry pressure adds value to most device designs.	<ul style="list-style-type: none"> Naturally hydrophobic or hydrophilic Compatible with strong acids and aggressive solutions Improved durability and handling 	<ul style="list-style-type: none"> Filtration of strong acids and aggressive solutions Venting applications Phase separations Aerosol samplings
Polyethylene	PE	The membrane has better solvent resistance than polycarbonate and captures all particles larger than the precisely controlled pore size on its surface.	<ul style="list-style-type: none"> Naturally hydrophilic so pre-treatments and wetting agents are not required Smooth, thin, glass-like surface for microscopic visualization Low protein binding ensures clean results 	<ul style="list-style-type: none"> Removal of red blood cells from plasma Air analysis Cellular assays and diagnostics Trace element analysis
Rigenrated Cellulose	RC	Made from pure cellulose without wetting agents. Chemical resistance to a wide variety of solvents. High wet strength. Hydrophilic, so suitable for aqueous and organic samples. Very low protein binding capacity. pH range ~3-12.	<ul style="list-style-type: none"> Hydrophilic Excellent chemical compatibility and resistance to organic solvents Low non-specific adsorption Superior thermal resistance High mechanical strength 	<ul style="list-style-type: none"> Filtration of Aqueous and Organic Solutions Particle removal from organic solvents or mixtures of aqueous and non-aqueous samples Ultra-cleaning and de-gassing solvents and mobile phases for HPLC Clarification Protein Chemistry
Polyvinylidene Fluoride	PVDF	Designed for high tensile strength, high solvent resistance, and low protein binding, making them suitable for bio-medical filtration, sterilization filtration, and HPLC sample preparation. pH range ~1-14.	<ul style="list-style-type: none"> Superior strength to withstand aggressive handling or use with automated equipment without breaking or tearing Low protein binding minimizes retention of proteins in solution Low extractables ensure tests will be clean with consistent results Lot-to-lot consistency ensures consistent flow and diffusion rates for dependable results every time 	<ul style="list-style-type: none"> Preparation of protein-containing solutions prior to chromatography or other instrument analyses. Useful for a wide range of applications, including aggressive and non-aggressive solvent-based mobile phase. Offers excellent chemical compatibility, even with aggressive acids and alcohols. Provides high flow rates and throughput, low extractables and broad chemical compatibility. Better protection of your analytical results.

Sample Volume Selection Guide

Volume	Product	Membrane Diameter	Filter	Housing	Pore Size (µm)	Sterile	Non Sterile			
< 1 mL	Separa	N/A	Polytetrafluoroethylene		0,20, 0,45	No	Yes			
			Regenerated Cellulose	Polypropylene,	0,20, 0,45	No	Yes			
			Nylon 66	PTFE and silicone	0,20, 0,45	No	Yes			
			Polyvinylidene Fluoride	septa	0,20, 0,45	No	Yes			
			Polyethersulfone		0,20, 0,45	No	Yes			
< 12 mL	Abluo 13	13 mm	Cellulose Acetate	Acrylic	0,22 0,45 0,8 1,2 5,0	Yes	Yes			
			Nylon 66	Acrylic	0,22 0,45 5,0	No	Yes			
			Mixed Cellulose Esters	Polypropylene	0,22 0,45	No	Yes			
			Polyethersulfone	Polypropylene	0,22 0,45	Yes	Yes			
			Polytetrafluoroethylene Hydrophilic	Polypropylene	0,22 0,45	No	Yes			
			Polytetrafluoroethylene	Polypropylene	0,22 0,45	No	Yes			
			Polyethylene	Polypropylene	0,22 0,50	No	Yes			
			Regenerated Cellulose	Polypropylene	0,22 0,45	No	Yes			
			Polyvinylidene Fluoride	Polypropylene	0,22 0,45	Yes	Yes			
			< 18 mL	Cameo 17 Duallayer	17 mm	Glass Fiber/Nylon	Polypropylene	0,22, 0,45, 5,0	No	Yes
Glass Fiber/Polypropylene	Polypropylene	0,22, 0,45				No	Yes			
Glass Fiber/Teflon	Polypropylene	0,22, 0,45				No	Yes			
Abluo 25	25 mm	Cellulose Acetate		Acrylic	0,22 0,45 0,8 1,2 5,0	Yes	Yes			
		Nylon 66		Polypropylene	0,22 0,45 5,0	Yes	Yes			
		Mixed Cellulose Esters		Polypropylene	0,22 0,45	Yes	Yes			
		Polyethersulfone		Polypropylene	0,22 0,45	Yes	Yes			
		Polytetrafluoroethylene Hydrophilic		Polypropylene	0,22 0,45	No	Yes			
		Polytetrafluoroethylene		Polypropylene	0,22 0,45	No	Yes			
		Polyethylene		Polypropylene	0,22 0,50	No	Yes			
		Regenerated Cellulose		Polypropylene	0,22 0,45	No	Yes			
		Polyvinylidene Fluoride		Polypropylene	0,22 0,45	Yes	Yes			
		Glass Fiber		Polypropylene	0,7 1,0 1,2 3,1	No	Yes			
		<180 mL		Cameo 33 Duallayer	30 mm	Glass Fiber/Nylon	Polypropylene	0,22, 0,45	No	Yes
						Glass Fiber/Polypropylene	Polypropylene	0,22, 0,45	No	Yes
						Glass Fiber/Teflon	Polypropylene	0,22, 0,45	No	Yes
						Glass Fiber/Acetate	Polypropylene	0,22, 0,45, 0,8	Yes	Yes
Glass Fiber/PES	Polypropylene		0,22, 0,45			No	Yes			

Syringeless Filters - SEPARA®



Save time and money in sample preparation process with SEPARA® syringeless filters. The single step filtering process is efficient, simple to use, easy to press and fast.



Features and Benefits

- ◆ Rapid sample preparation
- ◆ Single step process, filtering with a plunger in the vial
- ◆ Sample ready to use after filtration
- ◆ Pre-slitted cap ensures easy and clean sample transfer
- ◆ Replace syringe, syringe filter, glass vial and cap, reducing waste
- ◆ Increase sample integrity with all-in vial and filter
- ◆ Compatible with most auto-samplers
- ◆ Compatible with most multi-compressors

Characteristics

Dimensions: 12 mm diameter x 32 mm height
Materials: Polypropylene, PTFE and Silicone septa
Fill Line Volume: 480 microliter
Filtering Capacity: 450 microliter
Dead Volume: 30 microliter
Compression Force: 8 psi (0.6 bar)
Maximum operating temperature: 120°F (50°C)

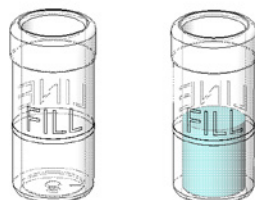

sample filling



press down to filter sample

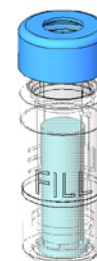

filtered sample ready for analysis

Ordering information

Membrane Material	Pore Size (µm)	Color	Product Code
			100/pk
Polytetrafluoroethylene (PTFE)	0.20	Pink	MV32ANPPT002TC01
Polytetrafluoroethylene (PTFE)	0.45	Red	MV32ANPPT004CC01
Regenerated Cellulose (RC)	0.20	Gray	MV32ANPRC002GC01
Regenerated Cellulose (RC)	0.45	Black	MV32ANPRC004LC01
Nylon (NY)	0.20	Light Blue	MV32ANPNY002BC01
Nylon (NY)	0.45	Blue	MV32ANPNY004UC01
Polyvinylidene Fluoride (PVDF)	0.20	Yellow	MV32ANPPV002FC01
Polyvinylidene Fluoride (PVDF)	0.45	Orange	MV32ANPPV004IC01
Polyethersulfone (PES)	0.20	Light Green	MV32ANPPS002EC01
Polyethersulfone (PES)	0.45	Dark Green	MV32ANPPS004WC01

13 mm ABLUO® Syringe Filters



Characteristics

Membrane Materials: Cellulose Acetate, Nitrocellulose (MCE), Nylon 66, PE, PES, PTFE, PVDF, Regenerated Cellulose
Membrane Diameter: 13 mm
Effective Filtration Area: 0.76 cm²
Housing Diameter: 18 mm
Housing Materials: Acrylic, Polypropylene, Ultrasonically welded
Inlet / Outlet: FLL / MLL-MLS
Holdup Volume: <50 microliter
Maximum Operating Temperature:
 PP Abluo - 90°C / 194°F, Acrylic Abluo 50°C / 122°F
Maximum Operating Pressure: 80 psi
Sterile: No

Typical Applications

- ▲ Filtration of Aqueous, Organic and Alcohol Solutions
- ▲ Analytical Sample Preparation
- ▲ IC Chromatography
- ▲ Fuel Hydraulic Fluids and Machined Parts
- ▲ Clarification
- ▲ Protein Chemistry
- ▲ Cell Culture

Ordering information

Membrane Material	Pore Size (µm)	End Fitting	Housing Material	Color	Product Code	
					Packaging 100/pk	Packaging 500/pk
Cellulose Acetate (CA)	0.22	FLL/MLL	Acrylic	Blue	FJ13ANCCA002DH01	FJ13ANCCA002DD01
Cellulose Acetate (CA)	0.45	FLL/MLL	Acrylic	Yellow	FJ13ANCCA004FH01	FJ13ANCCA004FD01
Cellulose Acetate (CA)	0.80	FLL/MLL	Acrylic	Green	FJ13ANCCA008EH01	FJ13ANCCA008ED01
Cellulose Acetate (CA)	1.20	FLL/MLL	Acrylic	Red	FJ13ANCCA012CH01	FJ13ANCCA012CD01
Cellulose Acetate (CA)	5.00	FLL/MLL	Acrylic	Brown	FJ13ANCCA050PH01	FJ13ANCCA050PD01
Nylon 66 (NY)	0.22	FLL/MLS	Polypropylene	Transparent	FJ13BNPNY002AH01	FJ13BNPNY002AD01
Nylon 66 (NY)	0.45	FLL/MLS	Polypropylene	Transparent	FJ13BNPNY004AH01	FJ13BNPNY004AD01
Nylon 66 (NY)	5.0	FLL/MLL	Acrylic	Transparent	N/A	FJ13ANCNY050AD01
Mixed Cellulose Esters (MCE)	0.22	FLL/MLS	Acrylic	Transparent	FJ13BNPNC002AH01	FJ13BNCNC002AD01
Mixed Cellulose Esters (MCE)	0.45	FLL/MLS	Acrylic	Transparent	FJ13BNPNC004AH01	FJ13BNCNC004AD01
Polyethersulfone (PES)	0.22	FLL/MLS	Polypropylene	Transparent	FJ13BNPPS002AH01	FJ13BNPPS002AD01
Polyethersulfone (PES)	0.45	FLL/MLS	Polypropylene	Transparent	FJ13BNPPS004AH01	FJ13BNPPS004AD01
Polytetrafluoroethylene Hydrophilic (PTFE HP)	0.22	FLL/MLS	Polypropylene	Transparent	FJ13BNPPH002AH01	FJ13BNPPH002AD01
Polytetrafluoroethylene Hydrophilic (PTFE HP)	0.45	FLL/MLS	Polypropylene	Transparent	FJ13BNPPH004AH01	FJ13BNPPH004AD01
Polyethylene (PE)	0.22	FLL/MLS	Polypropylene	Transparent	FJ13BNPPE002AH01	FJ13BNPPE002AD01
Polyethylene (PE)	0.50	FLL/MLS	Polypropylene	Transparent	FJ13BNPPE005AH01	FJ13BNPPE005AD01
Regenerated Cellulose (RC)	0.22	FLL/MLS	Polypropylene	Transparent	FJ13BNPRC002AH01	FJ13BNPRC002AD01
Regenerated Cellulose (RC)	0.45	FLL/MLS	Polypropylene	Transparent	FJ13BNPRC004AH01	FJ13BNPRC004AD01
Polyvinylidene Fluoride (PVDF)	0.22	FLL/MLS	Polypropylene	Transparent	FJ13BNPPV002AH01	FJ13BNPPV002AD01
Polyvinylidene Fluoride (PVDF)	0.45	FLL/MLS	Polypropylene	Transparent	FJ13BNPPV004AH01	FJ13BNPPV004AD01
Polytetrafluoroethylene (PTFE)	0.22	FLL/MLS	Polypropylene	Transparent	FJ13BNPPT002AH01	FJ13BNPPT002AD01
Polytetrafluoroethylene (PTFE)	0.45	FLL/MLS	Polypropylene	Transparent	FJ13BNPPT004AH01	FJ13BNPPT004AD01

33 mm ABLUO® Syringe Filters



Characteristics

Membrane Materials: Cellulose Acetate, Glass Fiber, Nitrocellulose, Nylon 66, PES, Polyethylene, PTFE, PVDF, Regenerated Cellulose
Housing Diameter: 33 mm
Membrane Diameter: 25 mm
Effective Filtration Area: 4.6 cm²
Housing Materials: Acrylic, Polypropylene Ultrasonically welded
Inlet / Outlet: FLL / MLL-MLS
Holdup Volume: <100 microliter
Maximum Operating Temperature:
 PP Abluo - 90°C / 194°F, Acrylic Abluo 50°C / 122°F
Maximum Operating Pressure: 80 psi
Sterile: No

Typical Applications

- ◆ Analytical sample preparation
- ◆ Biological fluids
- ◆ Buffer solutions
- ◆ Sterile filtering of tissue culture media
- ◆ Protein aqueous solutions
- ◆ Biofuel analysis
- ◆ HPLC sample preparation
- ◆ Pesticide testing
- ◆ Cannabis potency testing
- ◆ Neutraceutical sample preparation

Ordering information

Membrane Material	Pore Size (µm)	End Fitting	Housing Material	Color	Product Code	
					Packaging 100/pk	Packaging 500/pk
Cellulose Acetate (CA)	0.22	FLL/MLL	Acrylic	Blue	FJ25ANCCA002DH01	FJ25ANCCA002DD01
Cellulose Acetate (CA)	0.45	FLL/MLL	Acrylic	Yellow	FJ25ANCCA004FH01	FJ25ANCCA004FD01
Cellulose Acetate (CA)	0.80	FLL/MLL	Acrylic	Green	FJ25ANCCA008EH01	FJ25ANCCA008ED01
Cellulose Acetate (CA)	1.20	FLL/MLL	Acrylic	Red	FJ25ANCCA012CH01	FJ25ANCCA012CD01
Cellulose Acetate (CA)	5.00	FLL/MLL	Acrylic	Brown	FJ25ANCCA050PH01	FJ25ANCCA050PD01
Nylon 66 (NY)	0.22	FLL/MLS	Polypropylene	Transparent	FJ25BNPNY002AH01	FJ25BNPNY002AD01
Nylon 66 (NY)	0.45	FLL/MLS	Polypropylene	Transparent	FJ25BNPNY004AH01	FJ25BNPNY004AD01
Polyethersulfone (PES)	0.22	FLL/MLS	Polypropylene	Transparent	FJ25BNPPS002AH01	FJ25BNPPS002AD01
Polyethersulfone (PES)	0.45	FLL/MLS	Polypropylene	Transparent	FJ25BNPPS004AH01	FJ25BNPPS004AD01
Mixed Cellulose Esters (MCE)	0.22	FLL/MLS	Polypropylene	Transparent	FJ25BNPNC002AH01	FJ25BNPNC002AD01
Mixed Cellulose Esters (MCE)	0.45	FLL/MLS	Polypropylene	Transparent	FJ25BNPNC004AH01	FJ25BNPNC004AD01
Regenerated Cellulose (RC)	0.22	FLL/MLS	Polypropylene	Transparent	FJ25BNPRC002AH01	FJ25BNPRC002AD01
Regenerated Cellulose (RC)	0.45	FLL/MLS	Polypropylene	Transparent	FJ25BNPRC004AH01	FJ25BNPRC004AD01
Polyvinylidene Fluoride (PVDF)	0.22	FLL/MLS	Polypropylene	Transparent	FJ25BNPPV002AH01	FJ25BNPPV002AD01
Polyvinylidene Fluoride (PVDF)	0.45	FLL/MLS	Polypropylene	Transparent	FJ25BNPPV004AH01	FJ25BNPPV004AD01
Polytetrafluoroethylene (PTFE)	0.22	FLL/MLS	Polypropylene	Transparent	FJ25BNPPT002AH01	FJ25BNPPT002AD01
Polytetrafluoroethylene (PTFE)	0.45	FLL/MLS	Polypropylene	Transparent	FJ25BNPPT004AH01	FJ25BNPPT004AD01
Polytetrafluoroethylene Hydrophilic (PTFE HP)	0.22	FLL/MLS	Polypropylene	Transparent	FJ25BNPPH002AH01	FJ25BNPPH002AD01
Polytetrafluoroethylene Hydrophilic (PTFE HP)	0.45	FLL/MLS	Polypropylene	Transparent	FJ25BNPPH004AH01	FJ25BNPPH004AD01
Polyethylene (PE)	0.22	FLL/MLS	Polypropylene	Transparent	FJ25BNPPE002AH01	FJ25BNPPE002AD01
Polyethylene (PE)	0.50	FLL/MLS	Polypropylene	Transparent	FJ25BNPPE005AH01	FJ25BNPPE005AD01
Glass Fiber (GF)	0.70	FLL/MLS	Polypropylene	Transparent	FJ25BNPGF007AH01	FJ25BNPGF007AD01
Glass Fiber (GF)	1.00	FLL/MLS	Polypropylene	Transparent	FJ25BNPGF010AH01	FJ25BNPGF010AD01
Glass Fiber (GF)	1.20	FLL/MLS	Polypropylene	Transparent	FJ25BNPGF012AH01	FJ25BNPGF012AD01
Glass Fiber (GF)	3.10	FLL/MLS	Polypropylene	Transparent	FJ25BNPGF031AH01	FJ25BNPGF031AD01

ABLUO SUPREME



NEW ABLUO SUPREME SYRINGE FILTER

Step up your sample preparation with GVS ABLUO SUPREME Syringe Filters

I XU'qHgtu'c'tcpi g'qHf kur qucdrg'u{ t{pi g'f'ngt'f gxlegu'f guk p{gf 'v'q'r tqxk{ g'tcu'v'cpf 'gHf'elgpv'f'ntcvkp'qH' cswgqu'v'cpf 'qti cple'uqrwkqpu'y kj 'j k j 'r ctvewrcvg'eqv{p{v0

GVS Standard vs Supreme water recovery

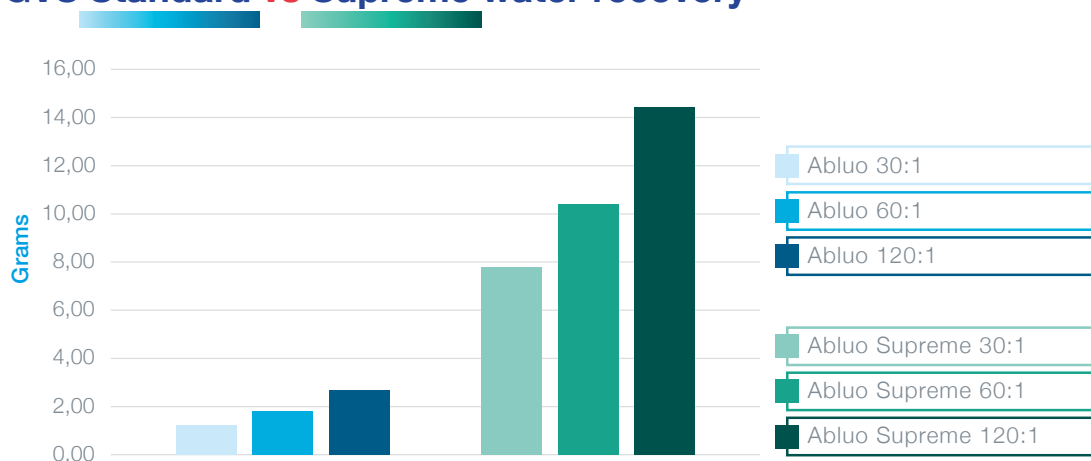

What's Special:

- ◆ Supreme Purification: Easily separate sediment and grit from samples, ensuring quality, and leaving you with the purest sample for your application.
- ◆ Supreme Flexibility: A full portfolio of products with various pore sizes, sterility options, and membranes available (including Hydrophilic PTFE)!
- ◆ Supreme Strength: Our most durable and robust syringe filter, the ABLUO SUPREME allows for the filtration of the heaviest sediment, resulting in a pure sample every time.
- ◆ Save Money: Use 1 ABLUO SUPREME in the place of 3 (or more) normal syringe filters!
- ◆ Save Operator Time and Effort: Two layers of pre-filter allow for the use of less force, making filtration faster and easier for lab techs!
- ◆ Save Sleep: Rest easy knowing that the ABLUO SUPREME Syringe Filter is made to conform to ISO standards.
- ◆ Save the environment: By using the ABLUO SUPREME, you are able to do the work of 5 and more normal syringe filters. Additionally, some ABLUO SUPREME models are compatible with an autoclave, meaning less plastic waste.

Technical Specifications

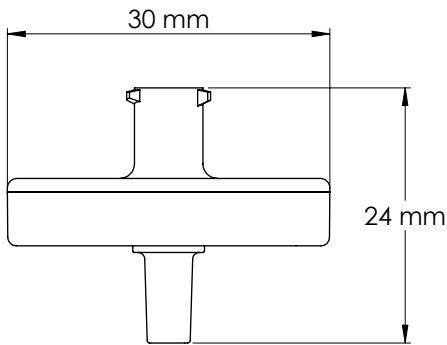

Membrane Diameter: 25 mm
Effective Filtration Area: 4.63 cm²
Housing Diameter: 30 mm
Housing Materials: Clear Polypropylene
Maximum Operating Temperature: 90°C / 194°F
Maximum Operating Pressure: 75 psi
Shelf Life (normal conditions): 3 years

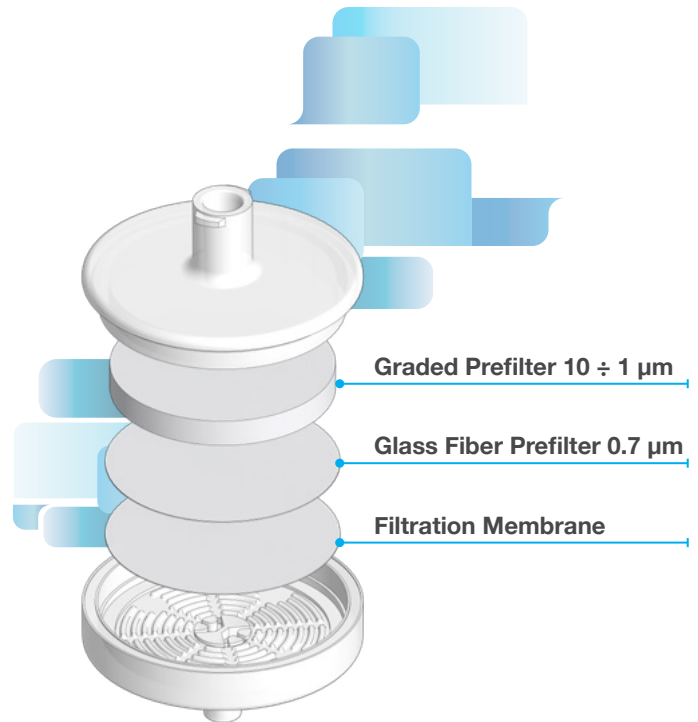

Ordering information

Membrane	Pore Size (µm)	Description	Product Code
NY	0.2	ABLUO SUPREME Syringe Filter 25mm, FLL/MLS - NY 0.2 µm	GF25BNPGN002AD01
NY	0.45	ABLUO SUPREME Syringe Filter 25 mm, FLL/MLS - NY 0.45 µm	GF25BNPGN004AD01
PES	0.2	ABLUO SUPREME Syringe Filter 25 mm, FLL/MLS - PES 0.2 µm	GF25BNPGS002AD01
PES	0.45	ABLUO SUPREME Syringe Filter 25 mm, FLL/MLS - PES 0.45 µm	GF25BNPGS004AD01
PTFE	0.2	ABLUO SUPREME Syringe Filter 25mm, FLL/MLS - PTFE 0.2 µm	GF25BNPGT002AD01
PTFE	0.45	ABLUO SUPREME Syringe Filter 25 mm, FLL/MLS - PTFE 0.45 µm	GF25BNPGT004AD01
PTFE (Hydrophilic)	0.2	ABLUO SUPREME Syringe Filter 25mm, FLL/MLS - PTFE Hydrophilic 0.2 µm	GF25BNPGH002AD01
PTFE (Hydrophilic)	0.45	ABLUO SUPREME Syringe Filter 25 mm, FLL/MLS - PTFE Hydrophilic 0.45 µm	GF25BNPGH004AD01
PVDF	0.2	ABLUO SUPREME Syringe Filter 25 mm, FLL/MLS - PVDF 0.2 µm	GF25BNPGV002AD01
PVDF	0.45	ABLUO SUPREME Syringe Filter 25 mm, FLL/MLS - PVDF 0.45 µm	GF25BNPGV004AD01
CA	0.2	ABLUO SUPREME Syringe Filter 25 mm, FLL/MLS - CA 0.2 µm	GF25BNPGA002AD01
CA	0.45	ABLUO SUPREME Syringe Filter 25 mm, FLL/MLS - CA 0.45 µm	GF25BNPGA004AD01

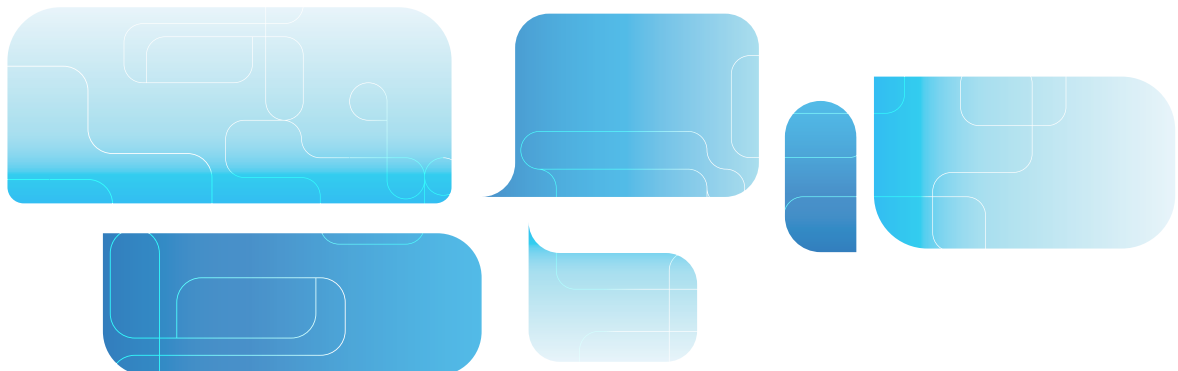



Applications

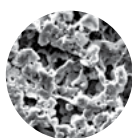

NY

Properties

Hydrophilic - Low protein binding - Superior strength - Resistant to organic solvents

Compounds Class

Bases, HPLC solvents, alcohols, aromatic hydrocarbons

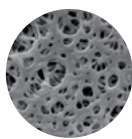

PES

Properties

Hydrophilic - Designed to remove particulates - Low protein and drug binding - High strength and durability

Compounds Class

Filtration of buffers and culture media

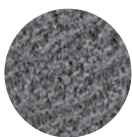

PTFE

Properties

Hydrophobic - Chemically and biologically inert - Superior chemical resistance

Compounds Class

Organic solvents, acids, alcohols, bases, aromatics

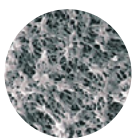

PTFE (Hydrophilic)

Properties

Hydrophilic - High chemical resistance - Low protein binding

Compounds Class

Aqueous and organic solutions

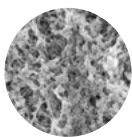

PVDF

Properties

Hydrophilic - Very low protein binding - High flow rates

Compounds Class

Alcohols, biomolecules

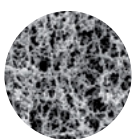

CA

Properties

Hydrophilic - Low non-specific binding - Low adsorption - Uniform pore structure

Compounds Class

Protein/Enzymes, protein recovery, tissue culture media filtration, wine filtration, pre-filtration of plasma fractions and vaccines

13 mm STERILE ABLUO® Syringe Filters



Characteristics

Membrane Materials: Cellulose Acetate, PES, PVDF
Housing Diameter: 18 mm
Membrane Diameter: 13 mm
Effective Filtration Area: 0.76 cm²
Housing Material: Acrylic Ultrasonically welded
Inlet / Outlet: FLL / MLL-MLS
Holdup Volume: <50 microliter
Maximum Operating Temperature: 50°C / 122°F
Maximum Operating Pressure: 80 psi
Sterile: Yes

Typical Applications

- ◆ Filtration of Aqueous Solutions
- ◆ Analytical Sample Preparation
- ◆ IC Chromatography
- ◆ Sterile Filtration and Clarification
- ◆ Protein Chemistry
- ◆ Cell Culture
- ◆ Clarification

Ordering information

Membrane Material	Pore Size (μm)	End Fitting	Housing Material	Color	Product Code
					Packaging 50/pk
Cellulose Acetate (CA)	0.22	FLL/MLL	Acrylic	Blue	FJ13ASCCA002DL01
Cellulose Acetate (CA)	0.45	FLL/MLL	Acrylic	Yellow	FJ13ASCCA004FL01
Cellulose Acetate (CA)	0.80	FLL/MLL	Acrylic	Green	FJ13ASCCA008EL01
Cellulose Acetate (CA)	1.20	FLL/MLL	Acrylic	Red	FJ13ASCCA012CL01
Cellulose Acetate (CA)	5.00	FLL/MLL	Acrylic	Brown	FJ13ASCCA050PL01
Polyethersulfone (PES)	0.22	FLL/MLS	Acrylic	Transparent	FJ13BSCPS002AL01
Polyethersulfone (PES)	0.45	FLL/MLS	Acrylic	Transparent	FJ13BSCPS004AL01
Polyvinylidene Fluoride (PVDF)	0.22	FLL/MLS	Acrylic	Transparent	FJ13BSCPV002AL01
Polyvinylidene Fluoride (PVDF)	0.45	FLL/MLS	Acrylic	Transparent	FJ13BSCPV004AL01

33 mm STERILE ABLUO® Syringe Filters



Characteristics

Membrane Materials: Cellulose Acetate, Nylon 66, PES, PVDF
Housing Diameter: 33 mm
Membrane Diameter: 25 mm
Housing Material: Acrylic Ultrasonically welded
Effective Filtration Area: 4.6 cm²
Inlet / Outlet: FLL / MLL-MLS
Holdup Volume: <100 microliter
Maximum Operating Temperature: 50°C / 122°F
Maximum Operating Pressure: 80 psi
Sterile: Yes

Typical Applications

- ◆ Filtration of Aqueous and Alcohol Solutions
- ◆ Sterile Filtration and Clarification
- ◆ Cell Culture
- ◆ Analytical Sample Preparation
- ◆ IC Chromatography
- ◆ Clarification
- ◆ Protein Chemistry
- ◆ Filtration of Aqueous and Organic Solutions

Ordering information

Membrane Material	Pore Size (μm)	End Fitting	Housing Material	Color	Product Code
					Packaging 50/pk
Cellulose Acetate (CA)	0.22	FLL/MLS	Acrylic	Transparent	FJ25BSCCA002AL01
Cellulose Acetate (CA)	0.45	FLL/MLS	Acrylic	Transparent	FJ25BSCCA004AL01
Cellulose Acetate (CA)	0.80	FLL/MLS	Acrylic	Transparent	FJ25BSCCA008AL01
Cellulose Acetate (CA)	0.22	FLL/MLL	Acrylic	Blue	FJ25ASCCA002DL01
Cellulose Acetate (CA)	0.45	FLL/MLL	Acrylic	Yellow	FJ25ASCCA004FL01
Cellulose Acetate (CA)	0.80	FLL/MLL	Acrylic	Green	FJ25ASCCA008EL01
Cellulose Acetate (CA)	1.20	FLL/MLL	Acrylic	Red	FJ25ASCCA012CL01
Cellulose Acetate (CA)	5.00	FLL/MLL	Acrylic	Brown	FJ25ASCCA050PL01
Mixed Cellulose Esters (MCE)	0.22	FLL/MLS	Acrylic	Transparent	FJ25BSCNC002AL01
Mixed Cellulose Esters (MCE)	0.45	FLL/MLS	Acrylic	Transparent	FJ25BSCNC004AL01
Nylon 66 (NY)	0.10	FLL/MLS	Acrylic	Transparent	FJ25BSCNY001AL01
Nylon 66 (NY)	0.22	FLL/MLS	Acrylic	Transparent	FJ25BSCNY002AL01
Nylon 66 (NY)	0.45	FLL/MLS	Acrylic	Transparent	FJ25BSCNY004AL01
Nylon 66 (NY)	1.20	FLL/MLS	Acrylic	Transparent	FJ25BSCNY012AL01
Nylon 66 (NY)	5.00	FLL/MLS	Acrylic	Transparent	FJ25BSCNY050AL01
Polyethersulfone (PES)	0.80	FLL/MLS	Acrylic	Transparent	FJ25BSCPS008AL01
Polyethersulfone (PES)	0.22	FLL/MLS	Acrylic	Transparent	FJ25BSCPS002AL01
Polyethersulfone (PES)	0.45	FLL/MLS	Acrylic	Transparent	FJ25BSCPS004AL01
Polyvinylidene Fluoride (PVDF)	0.22	FLL/MLS	Acrylic	Transparent	FJ25BSCPV002AL01
Polyvinylidene Fluoride (PVDF)	0.45	FLL/MLS	Acrylic	Transparent	FJ25BSCPV004AL01



We care about
your samples,
one drop at a time



FILTER TECHNOLOGY

**WORLDWIDE
DISTRIBUTION CENTERS:**

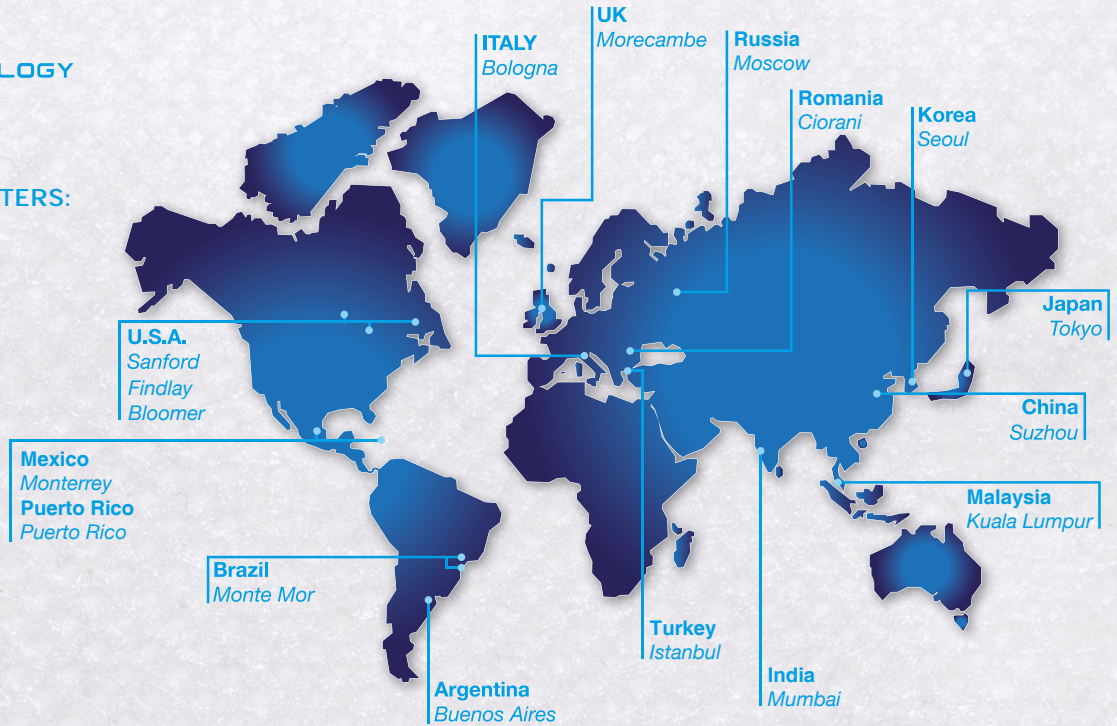

EUROPE

Italy Office
Headquarters
GVS S.p.A.
Via Roma 50
40069 Zola Predosa (BO) - Italy
Tel. +39 051 6176311
Fax +39 051 6176200
lifesciences.it@gvs.com

United Kingdom
GVS Filter Technology UK Ltd.
NFC House
Vickers Industrial Estate
Mellishaw Lane, Morecambe
Lancashire LA3 3EN
Tel. +44 (0) 1524 847600
lifesciences.uk@gvs.com

Russia
GVS Russia LLC
Profsoyuznaya Street, 25-A, office 102
117418, Moscow
Russian Federation (Russia)
Tel. +7 495 0045077
lifesciences.ru@gvs.com

Romania
GVS Microfiltrazione srl
Sat Ciorani de Sus 1E
107156 Ciorani
Prahova România
Tel. +40 244 463044
lifesciences.ro@gvs.com

Turkey
GVS Türkiye
Cevizli mah. Zuhul cad. Ritim Istanbul
no: 44 A-1 Blok D.371 Maltepe / Istanbul
Tel. +90 216 504 47 67
lifesciences.tr@gvs.com

ASIA

China
GVS Technology (Suzhou) Co., Ltd.
Fengqiao Civil-Run Sci-Tech Park,
602 Changjiang Road, S.N.D.
Suzhou, China 215129
Tel. +86 512 6661 9880
Fax: +86 512 6661 9882
lifesciences.cn@gvs.com

Japan
GVS Japan K.K.
KKD Building 4F, 7-10-12 Nishishinjuku
Shinjuku-ku, Tokyo 160-0023 Japan
Tel. +81 3 5937 1447
Fax +81 3 5937 1448
lifesciences.jp@gvs.com

Korea
GVS Korea Ltd #315 Bricks Tower
368 Gyungchun-ro(Gaun-dong),
472060 Namyangju-si, Gyunggi-do
Tel: +82 31 563 9873
Fax: +82 31 563 9874
lifesciences.kr@gvs.com

India
GVS Filter India Pvt Ltd
Unit No 35 & 36 on First Floor
Ratna Jyot Industrial Premises Irla Lane,
Irla Vile Parle, Mumbai 400056, India

Malaysia
GVS Filtration Sdn.Bhd
Lot No 10F-2B, 10th Floor, Tower 5 @ PFCC
Jalan Puteri 1/2, Bandar Puteri
47100 Puchong, Selangor
Malaysia

AMERICA

U.S.A.
GVS North America, Inc.
63 Community Drive
Sanford, ME 04073 - USA
Tel. +1 866 7361250
lifesciences.us@gvs.com

Puerto Rico
GVS Puerto Rico, LLC
98 Carr 194 - Fajardo,
Puerto Rico, 00738-2988, USA
Tel. +1.787.355.4100
e-mail: gvspuertorico@gvs.com

Mexico
GVS de México
Universal No. 550, Vynmsa Aeropuerto Apodaca
Industrial Park, Ciudad Apodaca, Nuevo León,
C.P. 66626 México
Tel. +52 81 2282 9003
lifesciences.mx@gvs.com

Brazil
GVS do Brasil Ltda.
Rodovia Conego Cyriaco Scaranello Pires 251
Jardim Chapadão, CEP 13193-580
Monte Mor (SP) - Brasil
Tel. +55 19 38797200
Fax +55 19 38797251
lifesciences.br@gvs.com

Argentina
GVS Argentina S.A.
Francisco Acuña de Figueroa
719 Piso:11 Of: 57
1416 Buenos Aires - Argentina
Tel. + 5411 48614750
lifesciences.ar@gvs.com



**CHROMATOGRAPHIC
SPECIALTIES INC.**



1-800-267-8103 • www.chromspec.com • tech@chromspec.com